

Article number: 2030120M20200A2U

Description: E+G levelling foot  
GN 30-120-M20-200-A2-U

Note: U Without nut, Hexagon socket at the top, Wrench flat at the bottom

## Measures

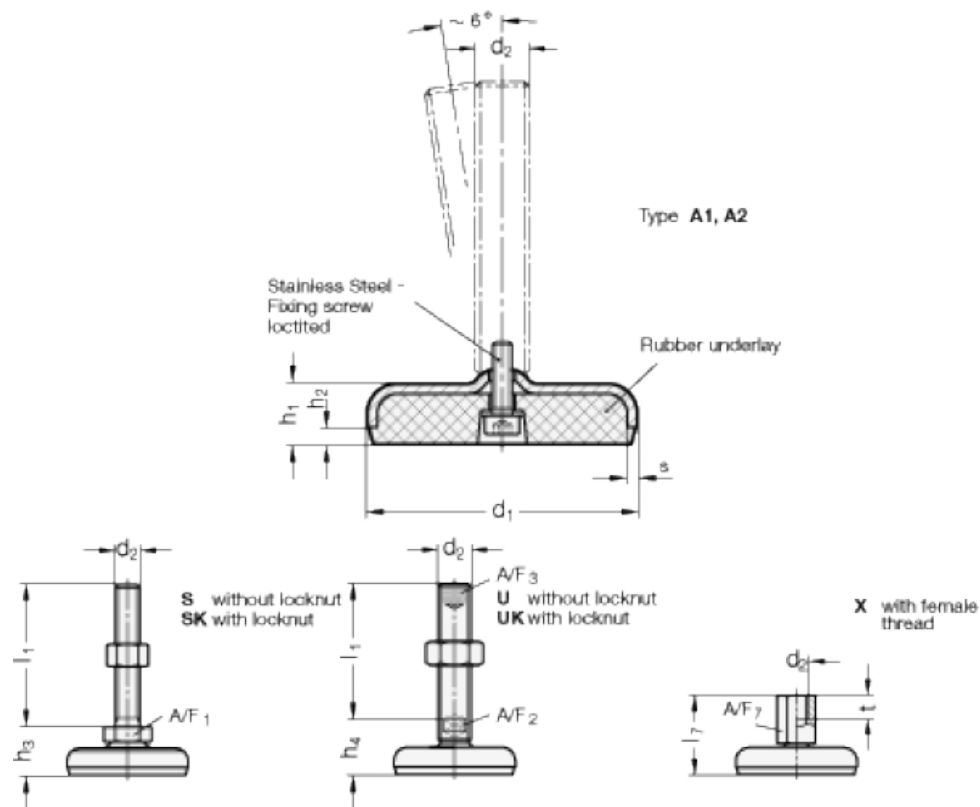

A/F2 = 15  
A/F3 = 10  
d1 = 120  
d2 = M20  
h1 = 22  
h2 = 6  
h4 = 39  
l1 = 200

s = 4